

Donaldson.
Torit®

**DOWNFLO® WORKSTATION
DUST COLLECTORS**

ULTRA-WEB®
High Efficiency Nanofiber Filters Built to Last



OUTPERFORMS ALL OTHER COLLECTORS

Downflo® WorkStations (DWS) fit anywhere on the plant floor and apply NO restrictions to worker movements or visibility. The full line of WorkStations is designed specifically for those in-plant areas where dirty and/or noisy operations are out in the open—grinding, sanding, chipping, batch mixing or welding.

The Downflo WorkStation's advantages are found in the collector's exclusive design and proprietary components. Featuring a ledgeless design in combination with proprietary Ultra-Web® filter media and ExtraLife™ cleaning technology, the DWS delivers exceptional performance in metalworking, woodworking, and process applications where high filtration efficiency and ledgeless construction is often a requirement.

The Downflo WorkStation Features

- Flexible, modular, self-contained workstations
- Proprietary Ultra-Web cartridge filters provide cleaner air longer
- Easy filter access requires no tools
- No hoods or ductwork required
- Energy savings – recirculate clean air and reduce the need for costly make-up air
- Ledgeless construction minimizes dust build up inside the collector
- Reversible louver inlets
- 10-year warranty



SIZES & OPERATIONS

DWS Models 4-1 to 6-4

- 8 standard model sizes
- Customized sizes available
- Many options and accessories

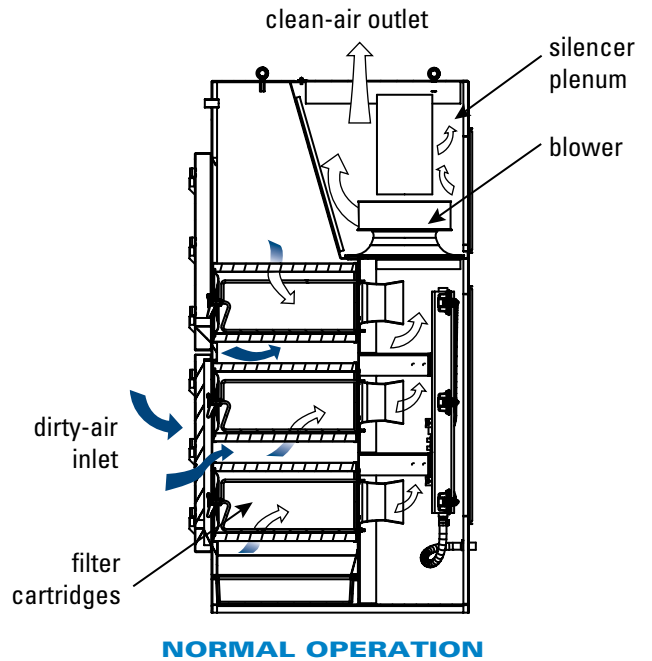

PULSE CLEANING TECHNOLOGY

ExtraLife™ Filter Cleaning System uses proprietary, computer-modeled pulse cleaning technology to easily “pulse off” any dust from the surface of the filter, improving filtration efficiency and prolonging filter life.

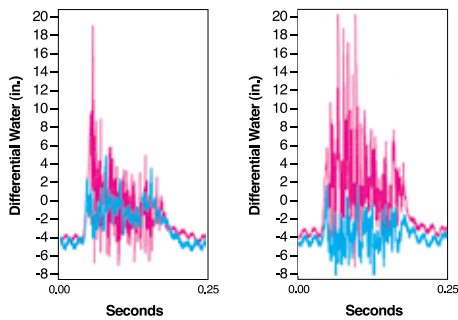

Pulse gradients produced by the standard Downflo during pulse cleaning compared to gradients produced by a Downflo with the ExtraLife Cleaning System (red).*

* The red lines show the increased pressure at the front of the Downflo filter generated by the ExtraLife system. The blue line show the pulse signature of a standard cartridge collector.

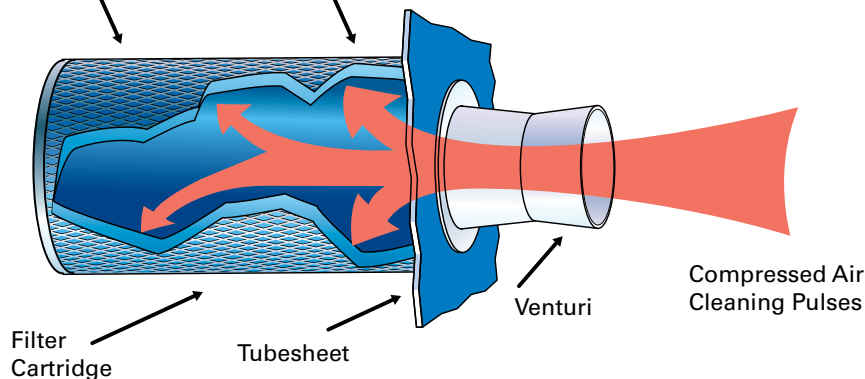

DOWNFLO PULSE PRESSURE GRADIENTS

ENGINEERED FOR RELIABLE PERFORMANCE

DOWNFLO WORKSTATION BOOTH PACKS

Sophisticated FLUENT®* airflow modeling software revealed that DWS booth packs are designed for adequate and consistent capture velocities at the booth opening and throughout the booth; a reflection of Donaldson Torit's commitment to technical research and development.

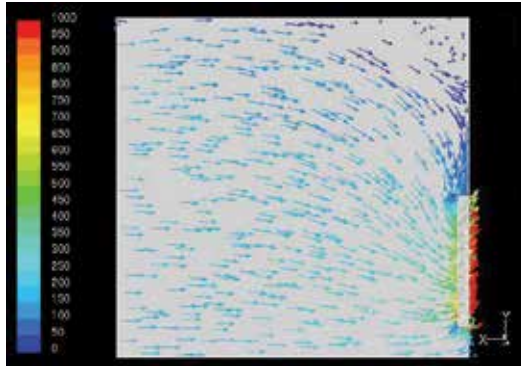

FLUENT® AIRFLOW BOOTH MODELING

- No system imbalance
- No air turbulence
- No hot spots
- No uncomfortable draft inside the booth that can upset working conditions

MANY DESIGN OPTIONS

DWS booths are designed to remove fine airborne contaminants from the workers' breathing zone and provide a cleaner working environment in metalworking, woodworking, and process applications.

Models**	Canopy with Side Shields	Soft-Wall Weld Curtains	Soft-Wall Acoustical Curtains	Hard-Wall Galvanized Panels	Hard-Wall Acoustical Panels
Purpose	Most basic booth/hooding arrangement	Lightweight structure for use under most light conditions	Lightweight structure for moderate sound control	Heavy-duty structure/ smooth walls for easy washdown	Heavy-duty structure for higher sound control
DWS 4-1	45 x 36 x 90 (1143 x 914 x 2286 mm)	—	—	—	—
DWS 4-2	90 x 36 x 90 (2286 x 914 x 2286 mm)	90 x 90 x 90 (2286 x 2286 x 2286 mm)	90 x 90 x 90 (2286 x 2286 x 2286 mm)	90 x 90 x 90 (2286 x 2286 x 2286 mm)	90 x 90 x 90 (2286 x 2286 x 2286 mm)
DWS 4-3	—	135 x 90 x 90 (3429 x 2286 x 2286 mm)	135 x 90 x 90 (3429 x 2286 x 2286 mm)	135 x 90 x 90 (3429 x 2286 x 2286 mm)	135 x 90 x 90 (3429 x 2286 x 2286 mm)
DWS 4-4	—	180 x 90 x 90 (4572 x 2286 x 2286 mm)	180 x 90 x 90 (4572 x 2286 x 2286 mm)	180 x 90 x 90 (4572 x 2286 x 2286 mm)	180 x 90 x 90 (4572 x 2286 x 2286 mm)
DWS 4-5+	—	Custom	Custom	Custom	Custom
DWS 6-1	45 x 36 x 90 (1143 x 914 x 2286 mm)	67.5 x 90 x 90 (1715 x 2286 x 2286 mm)	67.5 x 90 x 90 (1715 x 2286 x 2286 mm)	—	—
DWS 6-2	90 x 36 x 90 (2286 x 914 x 2286 mm)	135 x 90 x 90 (3429 x 2286 x 2286 mm)	135 x 90 x 90 (3429 x 2286 x 2286 mm)	90 x 90 x 90 (2286 x 2286 x 2286 mm)	90 x 90 x 90 (2286 x 2286 x 2286 mm)
DWS 6-3	—	180 x 90 x 90 (4572 x 2286 x 2286 mm)	180 x 90 x 90 (4572 x 2286 x 2286 mm)	135 x 90 x 90 (3429 x 2286 x 2286 mm)	135 x 90 x 90 (3429 x 2286 x 2286 mm)
DWS 6-4	—	Custom	Custom	180 x 90 x 90 (4572 x 2286 x 2286 mm)	180 x 90 x 90 (4572 x 2286 x 2286 mm)
DWS 6-4+	—	Custom	Custom	Custom	Custom

* FLUENT is a registered trademark of Fluent, Inc. ** Dimensions are width x depth x height in inches (millimeters)

DIMENSIONS & SPECIFICATIONS

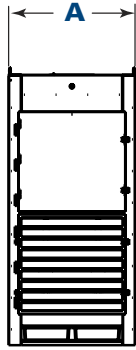

Front View
DWS 4-1, DWS 6-1 - Models

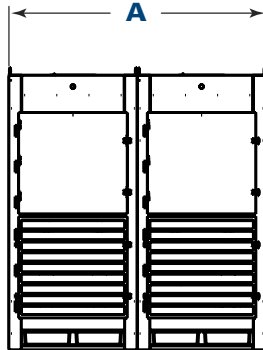

Front View
DWS 4-2, DWS 6-2 - Models

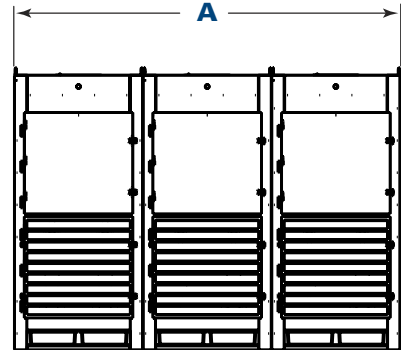

Front View
DWS 4-3, DWS 6-3 - Models

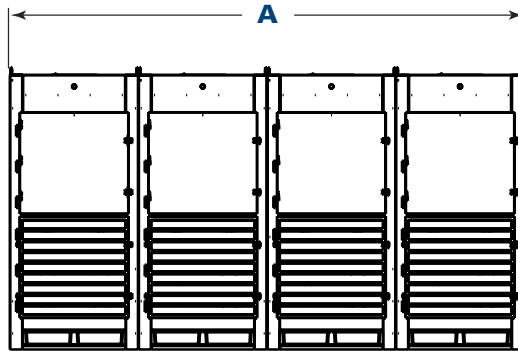

Front View
DWS 4-4, DWS 6-4 - Models

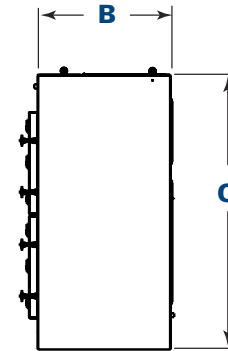

Side View
All Models

Base Model*	Modular Assemblies	Nominal Airflow**		No. of Filters	Ultra-Web Filter Area		No. of Modules	No. of Valves	No. of Dust Drawers	Shipping Weight		Dimensions					
		cfm	m ³ /h		ft ²	m ²				lb	kg	A		B		C	
												in	mm	in	mm	in	mm
DWS 4-1		4,500	7,644	4	760	70.6	1	4	2	1300	589.7	45.0	1143.0	47.8	1214.1	96.0	2438.4
	DWS 4-2	9,000	15,288	8	1520	141.2	2	8	4	2600	1179.3	90.0	2286.0	47.8	1214.1	96.0	2438.4
	DWS 4-3	13,500	22,932	12	2280	211.8	3	12	6	3900	1769.0	135.0	3429.0	47.8	1214.1	96.0	2438.4
	DWS 4-4	18,000	30,576	16	3040	282.4	4	16	8	5200	2358.7	180.0	4572.0	47.8	1214.1	96.0	2438.4
DWS 6-1		5,500	9,343	6	1140	105.9	1	6	2	1350	612.3	45.0	1143.0	47.8	1214.1	96.0	2438.4
	DWS 6-2	11,000	18,685	12	2280	211.8	2	12	4	2700	1224.7	90.0	2286.0	47.8	1214.1	96.0	2438.4
	DWS 6-3	16,500	28,028	18	3420	317.7	3	18	6	4050	1837.0	135.0	3429.0	47.8	1214.1	96.0	2438.4
	DWS 6-4	22,000	37,370	24	4560	423.6	4	24	8	5400	2449.4	180.0	4572.0	47.8	1214.1	96.0	2438.4

* The first number indicates number of filters in the power module, and the second number indicates number of power modules.

** Based on clean filters.

CARTRIDGE FILTER TECHNOLOGY

HIGH PERFORMANCE FILTERS

The Downflo Oval filter design is another indication of Donaldson Torit's commitment to technical research and development. The distinguishing factor in our filters is Ultra-Web® filtration technology. Ultra-Web nanofiber media uses a layer of fibers 0.2 to 0.3 microns in diameter to capture contaminants on the surface of the media less than one micron in size. The resulting dust cake is easily cleaned off during the automated collector cleaning cycles providing cleaner air longer, with a minimum MERV* 15 efficiency rating based on ASHRAE 52.2 - 2007 test standards.

10 micron



Nanofiber Media
(600x)

Nanofiber surface loading technology is available in all Ultra-Web and Fibra-Web filter cartridges.



Commodity Filter Media
(600x)

Conventional media has spaces of up to 60 µm between fibers, allowing dust to become deeply embedded.

CARTRIDGE FILTERS FOR MANY APPLICATIONS

The Downflo WorkStation in conjunction with Donaldson Torit's unique oval-shaped filter cartridges are an unbeatable system. Choose from our superior line of filters to complete the most powerful filtration solution available for your application.

STANDARD FEATURES & AVAILABLE OPTIONS

Collector Design	Std	Opt	Paint System	Std	Opt
Ledgeless Construction 14 Gauge	X		Primed inside and out, exterior surfaces finished blue	X	
Tubesheet, Base Plate 10 Gauge	X		Custom Color		X
Electrical Controls, Gauges & Enclosures					
High Performance Acoustical Airfoil Fans	X		Solid State Timer in NEMA 4 Enclosure	X	
Aluminum Fan Wheels	X		Delta P or Delta P Plus Control Panels		X
TEFC Motors – 5, 7.5 HP, 60 Hz	X		IEC Control Panel		X
TEFC Motors – 4, 5.5 kW, 50 Hz		X	Magnehelic®** Gauge		X
Fan Compartment Fully Lined w/Silencer Foam	X		Photohelic®** Gauge		X
ExtraLife™ Filter Cleaning System	X		Booth Options		
Compressed Air Required – 50 PSIG	X		Canopy w/Side Shields - Painted steel construction side panels swing out 90°.		X
Fully Lined and Silenced Clean Air Plenum	X		Soft-Wall Weld Curtains - Galvanized steel frames with clear PVC roof panels and blue translucent PVC side panels approved for welding.		X
Reversible Open Louver Inlet		X	Soft-Wall Acoustical Curtains - Galvanized steel frames with clear PVC roof and gray acoustical side panels.		X
Quick and Easy Filter Access	X		Hard-Wall Galvanized Panels		X
Acoustical Panel		X	Hard-Wall Acoustical Panels		X
Two Plastic Dust Drawers per Power Mod	X		Booth Lighting Packs		
Galvanized Steel Dust Drawers		X	• Industrial Light Fixtures		X
Integral Silencer	X		• Dust Tight Lens Fixtures		X
Chamber Silencer		X	• Flush Light Fixtures		X
Caster Packs		X	Sound Level***		
Downdraft Bench Pack		X	5 HP & 4 kW Power Packs – 63 dB(A)		
Bag-Out Bag (Filter & Dust Drawer)		X	7.5 HP & 5.5 kW Power Packs – 68 dB(A)		
Sprinkler Pipe Coupling	X		LAEq Pulse Average – 84-86 dB(A)		
Sprinkler Pack Assembly		X	Warranty		
Cartridge Filters					
Ultra-Web® (MERV® 15)	X		10-Year Warranty	X	
Ultra-Tek® (MERV 12); Thermo-Web™ (MERV 14); Fibra-Web® (MERV 14); Ultra-Web SB (MERV 15); Torit-Text™ (MERV 16), Ultra-Web® AS (MERV 15)		X			
HEPA/ASHRAE Afterfilters		X			

* The Minimum Efficiency Reporting Value (MERV) of this filter cartridge has been determined through independent laboratory testing using ASHRAE 52.2 (2007) test standards. The MERV rating was determined at a face velocity of 118 feet (36.0 meters) per minute and loading up to four inches (101.6 millimeters) water gauge. Actual efficiency of any filter cartridge will vary according to the specific application parameters. Dust concentration, airflow, particle characteristics, and pulse cleaning methods all affect filtration efficiency.

** Magnehelic and Photohelic are registered trademarks of Dwyer Instruments, Inc.

*** Sound measurements were taken in a hemianechoic chamber and under free-field conditions and do not reflect the influences of actual operating environments. Standard sound pressure levels were taken at an operator position of 1.5m high and 1m from each of the four sides of the cabinet.

Global Support

- Facilities in 37 countries
- 40 manufacturing plants and 14 distribution centers

Leading Technology

- Over 1,000 engineers and scientists worldwide
- Broad range of innovative collectors and filters
- 100s of filter media formulations

Experience and Service

- Technical expertise and support
- Ready-to-ship filters and parts within 24 hours

Call Donaldson®Torit® to get cleaner air today:

800-365-1331
DonaldsonTorit.com



Tel 800-365-1331 (USA)
Tel 800-343-3639 (within Mexico)

donaldsontorit@donaldson.com
donaldsontorit.com

Donaldson Company, Inc.
Torit
P.O. Box 1299
Minneapolis, MN
55440-1299 U.S.A.

EXACTLY WHAT YOU NEED.™

Downflow WorkStation Dust Collectors (04/14)
© 2004 Donaldson Company, Inc. All Rights Reserved. All products, product specifications, and data (airflow, capacity, dimensions, or availability) are subject to change without notice, and may vary by region or country. Donaldson Torit, Downflo, and Ultra-Web are registered trademarks of Donaldson Company, Inc. Contains Donaldson proprietary technology.